

RECOMMENDED PANEL CUTOUT

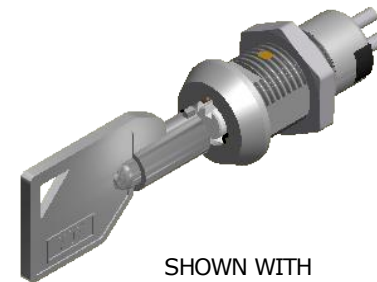

SHOWN WITH PROVIDED HEX NUT

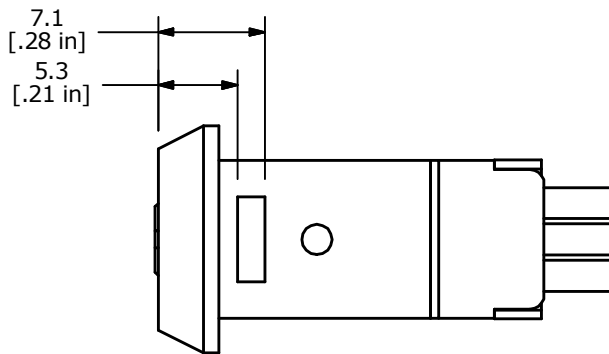
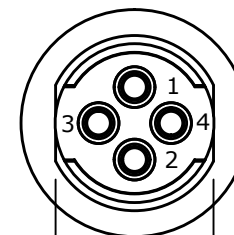
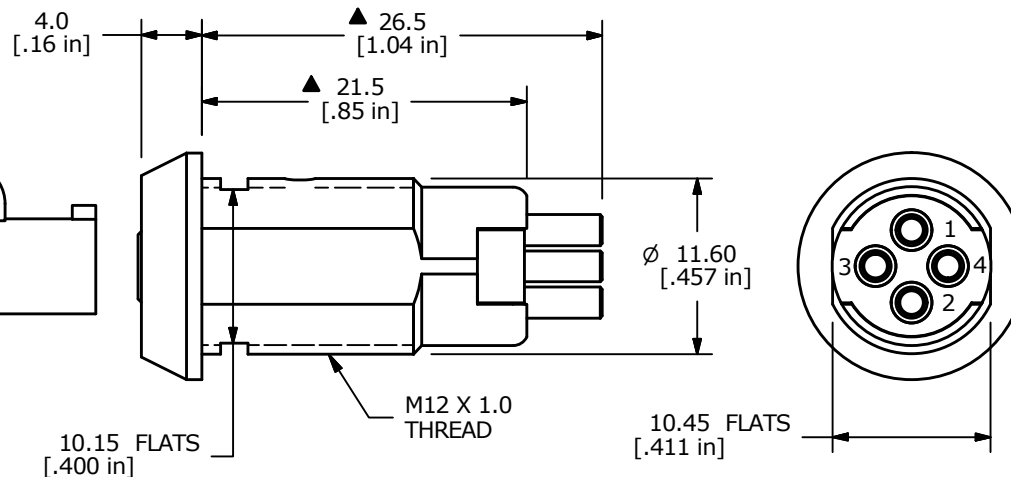
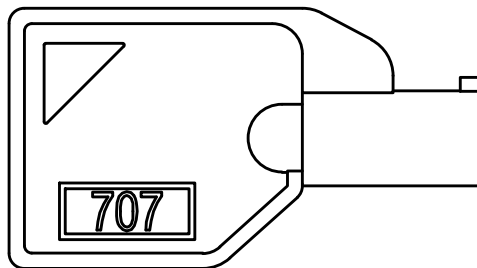
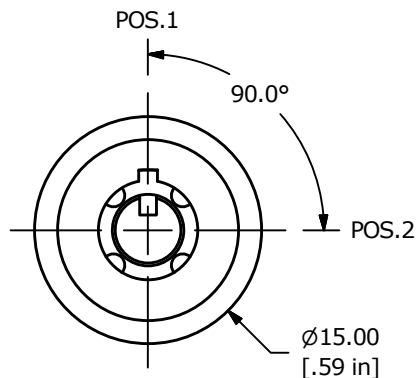

NOTE:

1. DIMENSIONS IN MM [INCH]
2. GENERAL TOLERANCE: X.X = ± 0.4
X.XX = ± 0.25
3. TERMINAL NUMBERS FOR REF ONLY
4. CONTACT RATINGS: 1A @ 125VAC, 0.5A @250VAC
5. CONTACT RESISTANCE: 10mΩ MAX.
6. INSULATION RESISTANCE: 200MΩ MIN.
7. DIELECTRIC STRENGTH: 1,000VAC FOR 1 MINUTE
8. ▲ DENOTES CRITICAL PARAMETER
9. MATERIALS:
HOUSING: ZINC ALLOY CAST
CYLINDER: ZINC ALLOY W/ CHROME PLATING
TERMINAL AND CONTACTS: SILVER PLATED
KEY: TUBULAR - ZINC ALLOY WITH CHROME PLATING
10. PANEL THICKNESS: 10MM MAX.
- ▲ 11. KEYCODE: 707 (QTY. 2)

LEGEND

- ⊙ = KEY PULL POSSIBLE IN THESE POSITIONS
- = DETENT POSITIONS

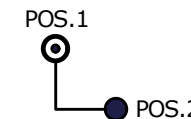

SWITCH FUNCTION	
CONNECTED TERMINAL #	
POS.1	POS.2
ON	ON
1-2	3-4

▲ CIRCUIT: SPDT (90° INDEXING) CONTACT CONFIGURATION



TITLE KO103C-707				
SCALE	DATE	DR	DWG	REV
2:1	3/24/2016	MJR	K100317	A

A	22225	NEW RELEASE	4/6/16	MJR
REV	PCR NO	DESCRIPTION	DATE	BY

THE INFORMATION CONTAINED IN THIS DOCUMENT IS PROPRIETARY TO E-SWITCH AND IS NOT TO BE COPIED OR TRANSFERRED