

▲ SWITCH FUNCTION		
POS. 1	POS. 2	POS. 3
ON	OFF	ON
2-3	OPEN	2-1

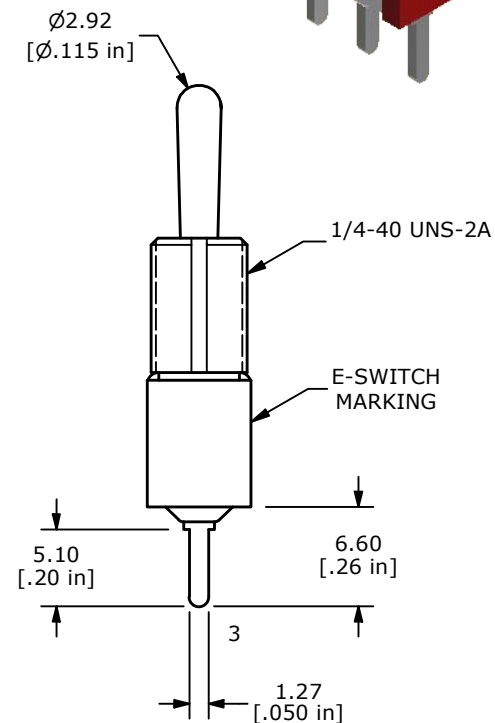

- NOTE:
1. ALL DIMENSIONS IN MM [INCH]
 2. GENERAL TOLERANCE: X.X = ±0.4
X.XX = ±0.25
 3. TERMINAL NUMBERS FOR REF ONLY
 - ▲ 4. PLATING MATERIAL: SILVER
 5. RATING: 2A @ 250 VAC
5A @ 120 VAC OR 28 VDC
 6. ELECTRIC LIFE: 40,000 MAKE-AND-BREAK CYCLES AT FULL LOAD.
 7. INSULATION RESISTANCE: 1,000 MEGA-OHM MIN.
 8. DIELECTRIC STRENGTH: 1,000 V RMS @ SEA LEVEL
 9. OPERATING TEMP.: -30°C to 85°C
 10. ▲ DENOTES CRITICAL PARAMETER.
 11. HARDWARE TO BE SHIPPED BULK
T100011 - LOCK WASHER - QTY 1
T100015 - LOCK RING - QTY 1
T100000 - HEX NUT - QTY 2

REV	ECO NO	DESCRIPTION	DATE	BY
D	ECO-101768	100 SERIES UPDATE	03/23/23	MR

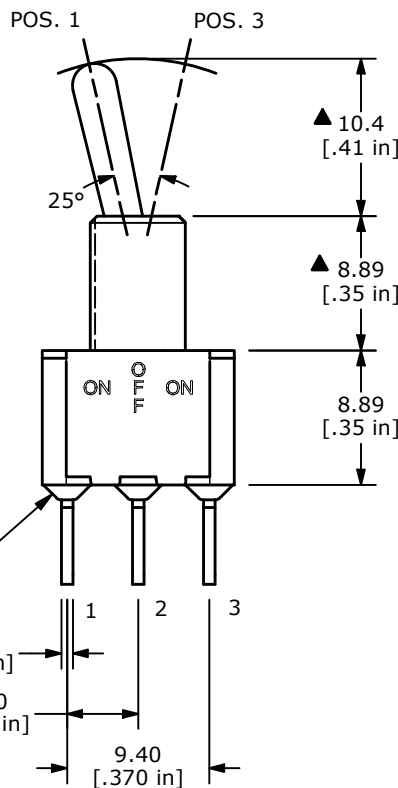

OBJECT ID
000023008

TITLE 100SP3T1B1M2QE H				
SCALE 2:1	DATE 4/18/2007	DR TN	DWG ST113013	REV D