

▲ CIRCUIT: SPST

NOTES

1. ALL DIMENSIONS IN MM [INCH]
2. GENERAL TOLERANCE: X.X=± 0.4
X.XX=± 0.25
3. TERMINAL NUMBERS FOR REF. ONLY.
- ▲ 4. OPERATING FORCE: 130± 50gf
5. OPERATING LIFE: 1,000,000 CYCLES
6. TRAVEL: 0.5± 0.15mm
7. CONTACT RATING: 12VDC @ 50mA
8. CONTACT RESISTANCE: 100m Ω MAX
9. INSULATION RESISTANCE: 100M Ω MIN @ 100VDC.
- ▲ 10. CONTACT MATERIAL: SILVER
11. OPERATING TEMPERATURE: -40°C TO 85°C
12. PACKAGING: TUBE 60 PCS. PER
13. ▲ DENOTES CRITICAL PARAMETER
14. 2002/95/EC (ROHS) COMPLIANT

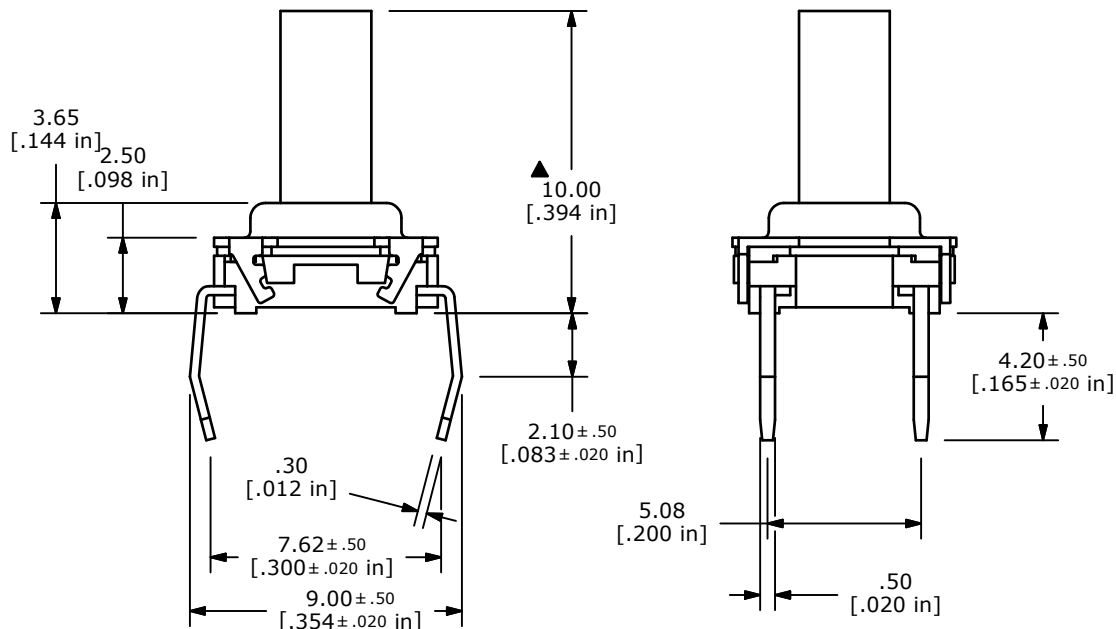

TITLE TL6100DF130QP

A	21179	New Release	7/23/13	rc
REV	PCR NO	DESCRIPTION	DATE	BY

SCALE	DATE	DR	DWG	REV
	5/31/2013	rc	T350012	A

THE INFORMATION CONTAINED IN THIS DOCUMENT IS PROPRIETARY TO E-SWITCH AND IS NOT TO BE COPIED OR TRANSFERRED