

ECM3025 SERIES FREE HANGING RECEPTACLE HOUSING

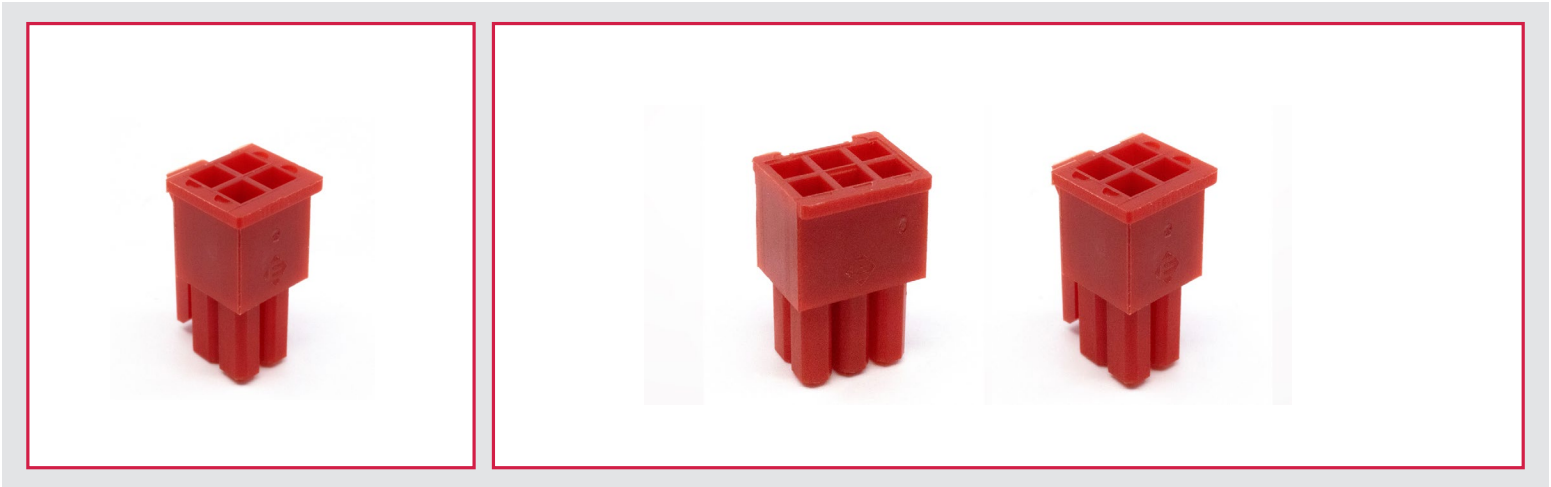

SPECIFICATIONS

Voltage Rating: 250VAC
Current Rating: 5A max
Housing: PA66, UL94V-0
Insulation Resistance: 100Mohm min
Withstanding: 100Mohm min
Operating Temperature: -25°C to +85°C
Poles: 2-10
Wire Range: 28-22AWG

FEATURES & BENEFITS

Free Hanging 3mm spacing
Wire to Wire Receptacle to Plug system
Compatible with ECM3022 and ECM3026 Series
Low Profile Design
2 to 10 Poles
ECM5556F2822C - socket terminals
Wire leads (500mm long) optional

PART NUMBER CONFIGURATOR

Series



ECM3025

Function



02 - 2 Pins
04 - 4 Pins
06 - 6 Pins
10 - 10 Pins

Color



R - Red

Wiring



None
W - 500mm wire leads*

NOTES:
 Specifications based on using ESW Crimp Terminals (Sold Separately)
 *22AWG AWM UL1007 Stranded

Specifications subject to change without notice 10/27/2025

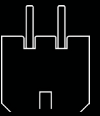

ECM3025 SERIES FREE HANGING RECEPTACLE HOUSING

BODY AND TERMINAL DIMENSIONS

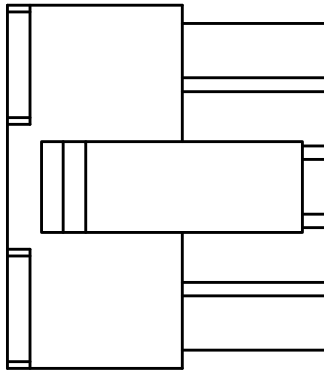

OBJECT NAME	NO. OF POS.	DIM "X"
ECM302502R	2	4.00 [.156 in]
ECM302504R	4	7.00 [.276 in]
ECM302506R	6	10.00 [.394 in]
ECM302510R	10	16.00 [.630 in]

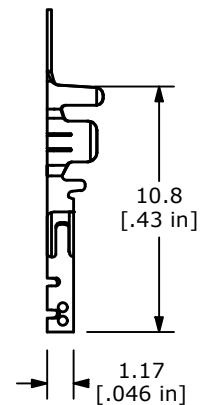
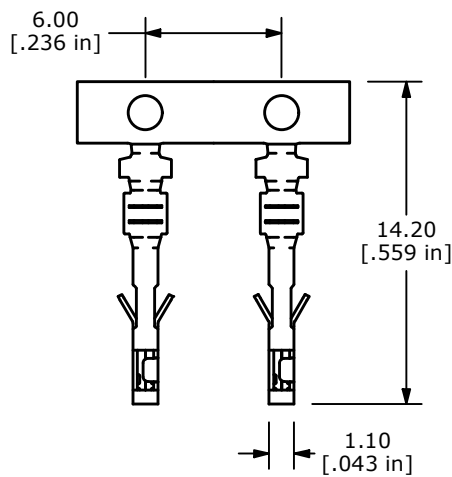
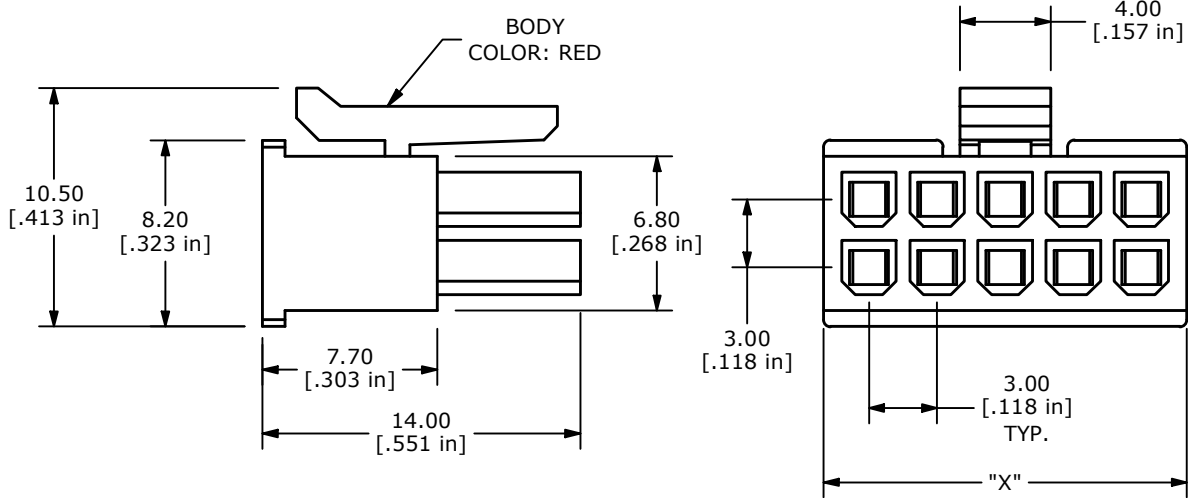

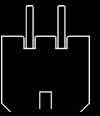

ECM3025 SERIES FREE HANGING RECEPTACLE HOUSING

PIN POSITIONS

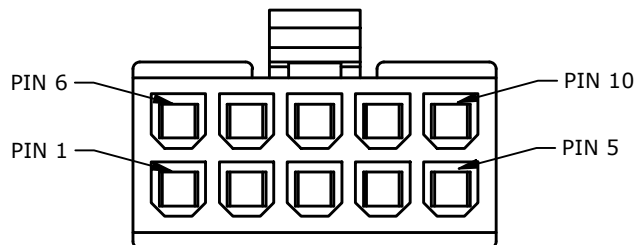
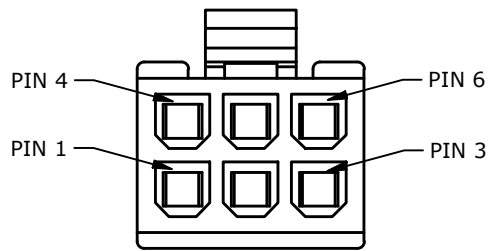
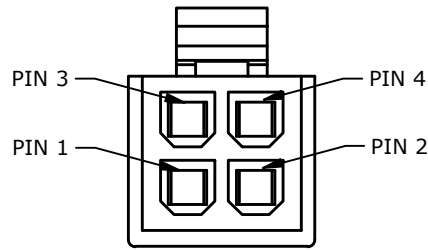
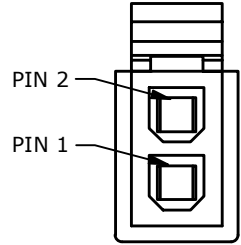

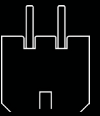

ECM3025 SERIES FREE HANGING RECEPTACLE HOUSING

WIRE LEAD

OBJECT NAME	NO. OF POS.	DIM "X"
ECM302502RW	2	3.85 [.152 in]
ECM302504RW	4	7.00 [.276 in]
ECM302506RW	6	10.00 [.394 in]
ECM302510RW	10	16.00 [.630 in]

CONNECTOR	WIRE
P1-1	WIRE, 22 AWG UL1007 STRANDED, BLACK
P1-2	WIRE, 22 AWG UL1007 STRANDED, RED
P1-3	WIRE, 22 AWG UL1007 STRANDED, GREEN
P1-4	WIRE, 22 AWG UL1007 STRANDED, BLUE
P1-5	WIRE, 22 AWG UL1007 STRANDED, PURPLE
P1-6	WIRE, 22 AWG UL1007 STRANDED, YELLOW
P1-7	WIRE, 22 AWG UL1007 STRANDED, GRAY
P1-8	WIRE, 22 AWG UL1007 STRANDED, PINK
P1-9	WIRE, 22 AWG UL1007 STRANDED, ORANGE
P1-10	WIRE, 22 AWG UL1007 STRANDED, WHITE

